

TDS PRODUCT IMAGE SHEET >





**VENTURA – INWARD GLIDER – DOOR LEAVES & SHAFTS**

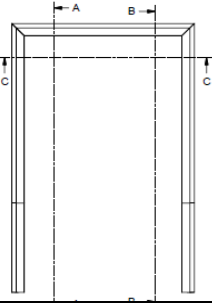
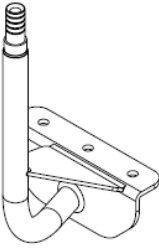
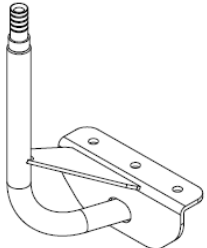

| Image   | TDS Part Number & Description  | OE Part Numbers<br>(WHERE FITTED)                              |
|---|--|--|
|    | <p><b>A249</b><br/>M8 DIN125A WASHER ZP</p>                                  | <p><b>A249</b> <i>Ventura</i></p>                              |
|   | <p><b>B253</b><br/>Ø16 NYLON BEARING BUSH<br/>ID=16x22. OD=22 F= Ø30x2.5</p> | <p><b>B253</b> <i>Ventura</i><br/>NBFL IG4</p>                 |
|  | <p><b>B326</b><br/>BOLT DIN 912 M6x30 DM</p>                                 | <p><b>B326</b> <i>Ventura</i><br/>WRIGHTBUS PS2</p>            |
|  | <p><b>B585</b><br/>PIVOT BOLT M6</p>   | <p><b>B585</b> <i>Ventura</i><br/>WRIGHTBUS STREETLITE IGE</p> |
|  | <p><b>B768</b><br/>END RUBBER PROFILE IG</p>                                 | <p><b>B768</b> <i>Ventura</i></p>                              |

|   |   |   |
|---|---|---|
|  <p>C130</p>   | <p><b>C130</b><br/>TAPPING STRIP 2xM8</p>   | <p><b>C130</b> <i>Ventura</i></p>   |
|                | <p><b>C449-100</b><br/>EDGE PROTECTION RUBBER</p>   | <p><b>C449-100</b> <i>Ventura</i><br/>WRIGHTBUS IG4</p>                           |
|  <p>C260</p>   | <p><b>C260</b><br/>POTENTIOMETER</p>  | <p><b>C260</b> <i>Ventura</i><br/>POLISH SCANIA OMNICITY DD<br/>IG3 &lt; 2007</p> |
|  <p>C272</p> | <p><b>C272</b><br/>HANDRAIL NYLON CAP</p>   | <p><b>C272</b> <i>Ventura</i></p>   |
|  <p>C456</p> | <p><b>C456</b><br/>Screw Din 916 M8x10 ZP</p>   | <p><b>C456</b> <i>Ventura</i></p>   |
|  <p>C670</p> | <p><b>C670</b><br/>GLASS SEALING TAPE 3x9 BLACK</p>   | <p><b>C670</b> <i>Ventura</i></p>   |
|  <p>D112</p> | <p><b>D112</b><br/>Ø 25 BEARING BLOCK FLCTEY<br/># FIXINGS = H425 Bolt, A808 Nut &amp; D870 Lock Disc</p> | <p><b>D112</b> <i>Ventura</i><br/>(IG3 DOORSHAFT ASSYS)</p>                       |

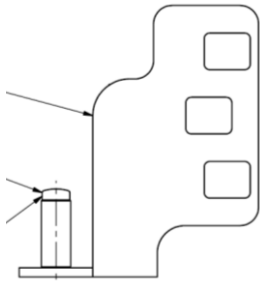
|   |   |   |
|---|---|---|
|    | <p><b>D331-###</b><br/>SENSITIVE EDGE STRIPS</p> <p># SEE CATEGORY ELECTRICAL SHEET FOR VEHICLE SPECIFIC SIZES &amp; P/Ns</p> | <p><b>D331-###</b> <i>Ventura</i></p>   |
|    | <p><b>D538</b><br/>THREAD BLOCK 2xM12</p>   | <p><b>D538</b> <i>Ventura</i></p>   |
|    | <p><b>E096</b><br/>CATCH PIN RIGHT (PS)</p>   | <p><b>E096</b> <i>Ventura</i><br/>EAST LANCS OLYMPUS DD IG3,<br/>POLISH SCANIA OMNICITY DD IG3</p>  |
|   | <p><b>E097</b><br/>CATCH PIN LEFT (PS)</p>  | <p><b>E097</b> <i>Ventura</i><br/>EAST LANCS OLYMPUS DD IG3,<br/>POLISH SCANIA OMNICITY DD IG3</p>  |
|  | <p><b>E818</b><br/>BOTTOM SUPPORT ASSY LEFT (PS)</p>  | <p><b>E818</b> <i>Ventura</i><br/>WRIGHTBUS ECLIPSE SD IG3 + GEMINI DD IG3, ADL E400 DD IG3, EAST LANCS SD IG3, POLISH SCANIA OMNICITY DD IG3</p> |
|  | <p><b>F010</b><br/>SPACER 19-15 L=5</p>   | <p><b>F010</b> <i>Ventura</i><br/>WRIGHTBUS IG4</p>   |
|  | <p><b>F302</b><br/>BOTTOM SUPPORT ASSY RIGHT (PS)</p>   | <p><b>F302</b> <i>Ventura</i><br/>WRIGHTBUS ECLIPSE SD IG3 + GEMINI DD IG3, ADL E400 DD IG3, EAST LANCS SD IG3, POLISH SCANIA OMNICITY DD IG3</p> |

|   |   |   |
|---|---|---|
|    | <p><b>F534</b><br/>BOLT M8x18 ZP</p>  | <p><b>F534</b> <i>Ventura</i></p>   |
|    | <p><b>F597</b><br/>DOORSEAL MIDDLE (IG)<br/>2200mm</p>                              | <p><b>F597</b> <i>Ventura</i></p>   |
|    | <p><b>F629</b><br/>FLAP BOTTOM RUBBER (IG)</p>                                      | <p><b>F629</b> <i>Ventura</i></p>   |
|   | <p><b>F629-002</b><br/>FLAP RUBBER L=600</p>  | <p><b>F629-002</b> <i>Ventura</i><br/><b>WRIGHTBUS STREETLITE IGE</b></p>           |
|  | <p><b>F640</b><br/>FLANGED BEARING BUSH<br/>Ø8x10 OD=10</p>                         | <p><b>F640</b> <i>Ventura</i></p>   |
|  | <p><b>F681</b><br/>Ø14 PLAIN SPH BEARING<br/>DIN648 GE14<br/>ID=14. OD=28x13.35</p> | <p><b>F681</b> <i>Ventura</i><br/>DOORSHAFT TOP ARM BEARING<br/><b>NBFL IG4</b></p> |

|   |  |   |
|---|--|---|
|    | <p><b>F858</b><br/>PORTAL RUBBER U-FRAME F617<br/>OMNI</p> | <p><b>F858</b> <i>Ventura</i><br/>POLISH SCANIA OMNICITY DD IG3</p> |
|    | <p><b>F864</b><br/>GUIDING BRACKET IG3 LH OMNI</p>         | <p><b>F864</b> <i>Ventura</i><br/>POLISH SCANIA OMNICITY DD IG3</p> |
|   | <p><b>F865</b><br/>GUIDING BRACKET IG3 RH OMNI</p>         | <p><b>F865</b> <i>Ventura</i><br/>POLISH SCANIA OMNICITY DD IG3</p> |
|  | <p><b>G202</b><br/>RUBBER ENDSTOP</p>                      | <p><b>G202</b> <i>Ventura</i><br/>NBFL RS</p>                       |
|  | <p><b>G257</b><br/>DOOR SHAFT SUPPORT ASSY LH<br/>IG3</p>  | <p><b>G257</b> <i>Ventura</i><br/>POLISH SCANIA OMNICITY DD IG3</p> |
|  | <p><b>G260</b><br/>CABLE CLAMP</p>                         | <p><b>G260</b> <i>Ventura</i></p>                                   |





|   |   |  |
|---|---|--|
|    | <p align="center"><b>G298</b><br/>DOOR SHAFT SUPPORT ASSY RH<br/>IG3</p>                        | <p align="center"><b>G298</b> <i>Ventura</i><br/>POLISH SCANIA OMNICITY DD IG3</p> |
|    | <p align="center"><b>G379</b><br/>LOWER IG.3 SHAFT BRKT ASSY LH<br/>(Bush if required=H074)</p> | <p align="center"><b>G379</b> <i>Ventura</i></p>                                   |
|    | <p align="center"><b>G446</b><br/>FLAP TOP RUBBER (IG)</p>                                      | <p align="center"><b>G446</b> <i>Ventura</i></p>                                   |
|   | <p align="center"><b>G613</b><br/>BLIND RIVET NUT</p>   | <p align="center"><b>G613</b> <i>Ventura</i></p>                                   |
|  | <p align="center"><b>G756</b><br/>RETAINING CLIP</p>  | <p align="center"><b>G756</b> <i>Ventura</i></p>                                   |
|  | <p align="center"><b>G932</b><br/>HANDRAIL BOLT</p>   | <p align="center"><b>G932</b> <i>Ventura</i></p>                                   |
|  | <p align="center"><b>G951</b><br/>PIVOT BOLT M10</p>  | <p align="center"><b>G951</b> <i>Ventura</i></p>                                   |

|   |  |  |
|---|--|--|
|                | <p><b>G955</b><br/>PIVOT PLATE</p>   | <p><b>G955</b> <i>Ventura</i></p>  |
|  <p>G967</p>   | <p><b>G967</b><br/>SUPPORT PLATE</p>   | <p><b>G967</b> <i>Ventura</i></p>  |
|                | <p><b>G968</b><br/>BUSH DIA 16-10 L=14</p>   | <p><b>G968</b> <i>Ventura</i><br/>WRIGHTBUS IG4</p>                                  |
|  <p>G989</p>  | <p><b>G989</b><br/>PIVOT PIN</p>   | <p><b>G989</b> <i>Ventura</i></p>  |
|  <p>H047</p> | <p><b>H047</b><br/>SHAFT FOR IGP HEIGHT ADJUST</p>   | <p><b>H047</b> <i>Ventura</i></p>  |
|              | <p><b>H072</b><br/>IG3 SHAFT BEARING BUSH<br/>IB=21. OD=29.25-30<br/>LG=30. F= Ø 38x5</p>  | <p><b>H072</b> <i>Ventura</i><br/>WRIGHTBUS IG3 DOORSHAFTS, NBFL<br/>IG4 PLAT</p>    |
|              | <p><b>H074</b><br/>Ø12.4 NYLON BEARING BUSH<br/>ID=12.4 OD=16.25<br/>LG=10, F= Ø22x2.0</p> | <p><b>H074</b> <i>Ventura</i><br/>(DOORSHAFT BEARING BUSH IG3<br/>LOWER BRACKET)</p> |

|   |   |  |
|---|---|--|
|  <p>H404</p>   | <p><b>H404</b><br/>FLAP FRAME HIGH WELD ASSY<br/>1290 LEFT</p>  | <p><b>H404</b> <i>Ventura</i></p>  |
|                | <p><b>H425</b><br/>M8x35 HEX HD SCREW 8.8 BZP</p>   | <p><b>H425</b> <i>Ventura</i></p>  |
|  <p>H437</p>   | <p><b>H437</b><br/>DOORSHAFT SUPPORT ASSY LH<br/>WRIGHT IG3</p>   | <p><b>H437</b> <i>Ventura</i><br/>WRIGHTBUS ECLIPSE SD IG3 + GEMINI<br/>DD IG3, ADL E400 DD IG3, EAST<br/>LANCS SD IG3</p>   |
|               | <p><b>H446-001</b><br/>PORTAL SEAL TOP – 1600L<br/>(I032, J165 PORTAL ASSY)</p>                         | <p><b>H446-001</b> <i>Ventura</i><br/>(ADL E400 DD IG3, POLISH SCANIA<br/>OMNICITY IG3 JAN08&gt;)</p>  |
|              | <p><b>H452-001</b><br/>PORTAL SEAL SIDE – 2200L<br/>(I032, J165, K092, K093, K526<br/>PORTAL ASSYS)</p> | <p><b>H452-001</b> <i>Ventura</i><br/>(ADL E400 DD IG3, WRIGHTBUS<br/>GEMINI DD IG4, EAST LANCS SD IG3 +<br/>OLYMPUS DD IG3,<br/>WRIGHTBUS NBFL DD IG4, POLISH<br/>SCANIA OMNICITY IG3 JAN08&gt;)<br/>NFBL IG4</p> |
|  <p>H460</p> | <p><b>H460</b><br/>FLAP FRAME HIGH WELD ASSY<br/>1290 RIGHT</p>   | <p><b>H460</b> <i>Ventura</i></p>  |
|  <p>H465</p> | <p><b>H465</b><br/>DOORSHAFT SUPPORT ASSY RH<br/>WRIGHT IG3</p>   | <p><b>H465</b> <i>Ventura</i><br/>WRIGHTBUS ECLIPSE SD IG3 + GEMINI<br/>DD IG3, ADL E400 DD IG3, EAST<br/>LANCS SD IG3</p>   |

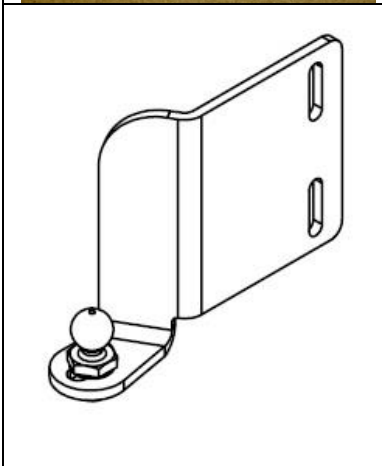
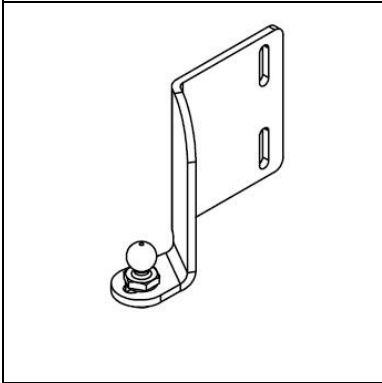

|   |   |  |
|---|---|--|
|    | <p><b>H469</b><br/>SHAFT IG3 CYLINDER Ø12</p>       | <p><b>H469</b> <i>Ventura</i></p>  |
|    | <p><b>H470</b><br/>PRECISION BOLT LOW</p>           | <p><b>H470</b> <i>Ventura</i></p>  |
|    | <p><b>H502</b><br/>GUIDE BRACKET LEFT IG</p>        | <p><b>H502</b> <i>Ventura</i><br/>WRIGHTBUS ECLIPSE SD IG3 + GEMINI DD IG3, ADL E300 SD IG3, EAST LANCS SD IG3</p> |
|   | <p><b>H506</b><br/>PORTAL RUBBER U PROFILE 1290</p> | <p><b>H506</b> <i>Ventura</i><br/>WRIGHTBUS ECLIPSE SD IG3 + GEMINI DD IG3, EAST LANCS SD IG3</p>                  |
|  | <p><b>H508</b><br/>GUIDE BRACKET RIGHT IG</p>       | <p><b>H508</b> <i>Ventura</i><br/>WRIGHTBUS ECLIPSE SD IG3 + GEMINI DD IG3, ADL E300 SD IG3, EAST LANCS SD IG3</p> |
|  | <p><b>H671</b><br/>SCREW M8x25 TORX ZP</p>          | <p><b>H671</b> <i>Ventura</i></p>  |
|  | <p><b>H699</b><br/>SCREW M8x16 TORX ZP</p>          | <p><b>H699</b> <i>Ventura</i></p>  |

|   |  |   |
|---|--|---|
|    | <p><b>H706</b><br/>BUSH 10-6,5 L=12</p>        | <p><b>H706</b> <i>Ventura</i></p>   |
|    | <p><b>H714</b><br/>SLIDE PLATE POM LEFT</p>    | <p><b>H714</b> <i>Ventura</i><br/>WRIGHTBUS ECLIPSE SD IG3 + GEMINI DD IG3, ADL E300 SD IG3, EAST LANCS SD IG3 + OLYMPUS DD IG3, POLISH SCANIA OMNICITY DD IG3 , TEMSA SD IG4</p> |
|   | <p><b>H776</b><br/>BOTTOM SUPPORT LH 135</p>   | <p><b>H776</b> <i>Ventura</i></p>   |
|  | <p><b>H777</b><br/>BOTTOM SUPPORT RH 135</p>   | <p><b>H777</b> <i>Ventura</i></p>   |
|  | <p><b>H793</b><br/>SLIDE PLATE POM RIGHT</p>   | <p><b>H793</b> <i>Ventura</i><br/>WRIGHTBUS ECLIPSE SD IG3 + GEMINI DD IG3, ADL E300 SD IG3, EAST LANCS SD IG3 + OLYMPUS DD IG3, POLISH SCANIA OMNICITY DD IG3 , TEMSA SD IG4</p> |
|  | <p><b>H901</b><br/>HANDRAIL PLASTIC SPACER</p> | <p><b>H901</b> <i>Ventura</i><br/>NBFL IG4, NBFL IG4 PLAT</p>   |

|   |  |  |
|---|--|--|
|  <p>H987</p>   | <p><b>H987</b><br/>DOORSHAFT SUPPORT ASY LH IG3</p>                                  | <p><b>H987</b> <i>Ventura</i><br/>WRIGHTBUS ECLIPSE SD IG3 + GEMINI DD IG3, ADL E400 DD IG3, EAST LANCS SD IG3 + OLYMPUS DD IG3, POLISH SCANIA OMNICITY DD IG3</p> |
|  <p>H988</p>   | <p><b>H988</b><br/>DOORSHAFT SUPPORT ASSY RH IG3</p>                                 | <p><b>H988</b> <i>Ventura</i><br/>WRIGHTBUS ECLIPSE SD IG3 + GEMINI DD IG3, ADL E400 DD IG3, EAST LANCS SD IG3 + OLYMPUS DD IG3, POLISH SCANIA OMNICITY DD IG3</p> |
|               | <p><b>I032</b><br/>PORTAL RUBBER U PROFILE 1350</p>                                  | <p><b>I032</b> <i>Ventura</i><br/>ADL E400 DD IG3</p>  |
|              | <p><b>I162</b><br/>IG4 SHAFT BEARING BUSH<br/>IB=21. OD=32-33<br/>LG=30. F=Ø38x5</p> | <p><b>I162</b> <i>Ventura</i><br/>ADL IG3 DOORSHAFTS<br/>ALL IG4 DOORSHAFTS (2010&gt;)</p>   |
|  <p>I187</p> | <p><b>I187</b><br/>POTENTIOMETER 125 DEG WITH CABLE ASSY</p>                         | <p><b>I187</b> <i>Ventura</i><br/>POLISH SCANIA OMNICITY IG3 2008 &gt;</p>   |
|  <p>I220</p> | <p><b>I220</b><br/>PIVOT POINT BOLT SHORT IG3</p>                                    | <p><b>I220</b> <i>Ventura</i></p>  |

|   |  |   |
|---|--|---|
|    | <p><b>I221</b><br/>RING</p>                                  | <p><b>I221</b> <i>Ventura</i></p>   |
|    | <p><b>I291</b><br/>DOOR GUIDING BRACKET</p>                  | <p><b>I291</b> <i>Ventura</i><br/>EAST LANCS OLYMPUS DD IG3</p>   |
|    | <p><b>I357</b><br/>DOORSHAFT SUPPORT ASSY LH<br/>IG3 100</p> | <p><b>I357</b> <i>Ventura</i><br/>ADL E200 SD IG4 + E300 SD IG3/IG4 +<br/>E400 DD IG3/IG4, TEMSA SD IG4</p> |
|   | <p><b>I358</b><br/>DOORSHAFT SUPPORT ASSY RH<br/>IG3 100</p> | <p><b>I358</b> <i>Ventura</i><br/>ADL E200 SD IG4 + E300 SD IG3/IG4 +<br/>E400 DD IG3/IG4, TEMSA SD IG4</p> |
|  | <p><b>I461</b><br/>GUIDING BRACKET</p>                       | <p><b>I461</b> <i>Ventura</i><br/>ADL E400 DD IG3</p>   |
|  | <p><b>I571</b><br/>PLUG</p>                                  | <p><b>I571</b> <i>Ventura</i></p>   |

|   |   |  |
|---|---|--|
|    | <p><b>I714</b><br/>GUIDING SHAFT ASSY<br/>106 x Ø28 with <i>CABLE ENTRY</i></p> <p># ROLLER ASSY = J301</p> | <p><b>I714</b> <i>Ventura</i><br/>EAST LANCS SD/DD IG3 , MCV SD IG4,<br/>ADL E200 SD IG4 + E400 DD IG4<br/>(SENS EDGE CABLE ENTRY)</p>   |
|    | <p><b>I893</b><br/>GUIDING SHAFT ASSY<br/>99 x Ø28 with <i>CABLE ENTRY</i></p> <p># ROLLER ASSY = J301</p>  | <p><b>I893</b> <i>Ventura</i><br/>ADL E400 DD IG3, POLISH SCANIA<br/>OMNICITY DD IG3</p>   |
|    | <p><b>I944</b><br/>GUIDING BRACKET IG</p>   | <p><b>I944</b> <i>Ventura</i><br/>TEMSA SD IG4</p>   |
|   | <p><b>J964</b><br/>GUIDING BRACKET FLAT</p>   | <p><b>J964</b> <i>Ventura</i><br/>ADL E200 IG3</p>   |
|  | <p><b>I989</b><br/>GUIDING SHAFT ASSY<br/>78 x Ø28 with <i>CABLE ENTRY</i></p> <p># ROLLER ASSY = J301</p>  | <p><b>I989</b> <i>Ventura</i><br/>WRIGHTBUS DD DUBLIN + GEMINI<br/>DD IG4 + NBFL DD IG4/IG4 PLAT, ADL<br/>E300 SD IG3 + DD E400+500 IG3<br/>DUBLIN, TEMSA SD IG4<br/>(SENS EDGE CABLE ENTRY)</p> |
|  | <p><b>I995</b><br/>SLIDE PLATE LEFT EXTENDED</p>  | <p><b>I995</b> <i>Ventura</i><br/>WRIGHTBUS ECLIPSE SD IG4 + GEMINI<br/>DD IG4 + STREETLITE SD IG4 + NBFL<br/>IG4/IG4 PLAT, ADL E300 SD IG4 +<br/>E400 DD IG4, MCV SD 112/124RLE IG4</p>         |
|  | <p><b>I996</b><br/>SLIDE PLATE RIGHT EXTENDED</p>   | <p><b>I996</b> <i>Ventura</i><br/>WRIGHTBUS ECLIPSE SD IG4 + GEMINI<br/>DD IG4 + STREETLITE SD IG4 + NBFL<br/>IG4/IG4 PLAT, ADL E300 SD IG4 +<br/>E400 DD IG4, MCV SD 112/124RLE IG4</p>         |





|   |  |  |
|---|--|--|
|    | <p align="center"><b>J122</b><br/>DOOR SHAFT SUPPORT LEFT</p>  | <p align="center"><b>J122</b> <i>Ventura</i><br/>MCV SD 112/124RLE IG4</p>   |
|    | <p align="center"><b>J123</b><br/>DOOR SHAFT SUPPORT RIGHT</p>   | <p align="center"><b>J123</b> <i>Ventura</i><br/>MCV SD 112/124RLE IG4</p>   |
|   | <p align="center"><b>J163-001</b><br/>PORTAL SEAL SIDE – 2350L<br/><br/>(I694,J205,J462,J469<br/>PORTAL ASSYS)</p> | <p align="center"><b>J163-001</b> <i>Ventura</i><br/>(ADL E400 DD IG3, ADL E300 SD IG4 +<br/>E400 DD IG4, ADL E200 SD IG4)</p> |
|  | <p align="center"><b>J164-001</b><br/>PORTAL SEAL TOP – 1600L<br/><br/>(I694,J205,J462,J469<br/>PORTAL ASSYS)</p>  | <p align="center"><b>J164-001</b> <i>Ventura</i><br/>(ADL E400 DD IG3, ADL E300 SD IG4 +<br/>E400 DD IG4, ADL E200 SD IG4)</p> |
|  | <p align="center"><b>J199</b><br/>COVER CAP</p>  | <p align="center"><b>J199</b> <i>Ventura</i></p>   |
|  | <p align="center"><b>J205</b><br/>PORTAL RUBBER U PROFILE 1350</p>   | <p align="center"><b>J205</b> <i>Ventura</i><br/>ADL E300 SD IG4 + E400 DD IG4</p>   |
|  | <p align="center"><b>J301</b><br/>28mm IG GUIDE ROLLER ASSY<br/>(E503+504)</p>                                     | <p align="center"><b>J301</b> <i>Ventura</i><br/>(ALL VS GUIDING SHAFT ASSYS)</p>  |

|  |  |   |
|--|--|---|
|  | <p><b>J302</b><br/>GUIDE SHAFT/ROLLER<br/>85 x Ø28<br/>(SEE ASSY L067)</p> <p># ROLLER ASSY = J301</p> | <p><b>J302</b> <i>Ventura</i><br/>WRIGHTBUS ECLIPSE SD IG3 + GEMINI DD IG4, ADL E400 DD IG3, EAST LANCS OLYMPUS DD IG3, MCV SD 112/124RLE IG4<br/>(NO CABLE ENTRANCE)</p> |
|  | <p><b>J462</b><br/>PORTAL RUBBER U FRAME</p>   | <p><b>J462</b> <i>Ventura</i><br/>ADL E200 SD IG4</p>   |
|  | <p><b>J469</b><br/>PORTAL RUBBER U FRAME ADL</p>   | <p><b>J469</b> <i>Ventura</i><br/>ADL E300 SD IG3/IG4 + E400 DD IG4</p>   |
|  | <p><b>K097-001</b><br/>PORTAL SEAL TOP – 1600L<br/>(K092, K093, K526 PORTAL ASSYS)</p>                 | <p><b>J163-001</b> <i>Ventura</i><br/>WRIGHTBUS GEMINI DD IG4, EAST LANCS SD IG3 + OLYMPUS DD IG3</p>   |
|  | <p><b>K092</b><br/>PORTAL RUBBER U PROFILE 1290</p>  | <p><b>K092</b> <i>Ventura</i><br/>WRIGHTBUS GEMINI DD IG4, EAST LANCS SD IG3 + OLYMPUS DD IG3, WRIGHTBUS NBFL DD IG4</p>  |
|  | <p><b>K093 (J165)</b><br/>PORTAL RUBBER U PROFILE 1200</p>   | <p><b>K093</b> <i>Ventura</i><br/>POLISH SCANIA OMNICITY (JAN08 &gt;)</p>   |
|  | <p><b>K095</b><br/>PORTAL RUBBER U PROFILE 1250<br/>(HESS)</p>   | <p><b>K095</b> <i>Ventura</i><br/>WRIGHTBUS NBFL DD IG4</p>   |

|   |  |   |
|---|--|---|
|    | <p><b>K522</b><br/>SLIDE PLATE LEFT</p>  | <p><b>K522</b> <i>Ventura</i><br/>MCV SD 112/124RLE IG4</p>   |
|    | <p><b>K523</b><br/>SLIDE PLATE RIGHT</p>   | <p><b>K523</b> <i>Ventura</i><br/>MCV SD 112/124RLE IG4</p>   |
|    | <p><b>K745</b><br/>FLAP TORSION SPRING</p>   | <p><b>K745</b> <i>Ventura</i><br/>IG3 ACTIVE FLAPS</p>  |
|   | <p><b>L067</b><br/>GUIDE ROLLER ASSY<br/>85 x Ø28<br/><br/># ROLLER ASSY = J301</p>                    | <p><b>L067</b> <i>Ventura</i><br/>WRIGHTBUS ECLIPSE SD IG3 + GEMINI DD IG4, ADL E400 DD IG3, EAST LANCS OLYMPUS DD IG3, MCV SD 112/124RLE IG4 (NO CABLE ENTRANCE)</p> |
|  | <p><b>L190</b><br/>CONNECTOR 2-POLE RECEPTACLE</p>   | <p><b>L190</b> <i>Ventura</i><br/>WRIGHTBUS STREETLITE IGE, NBFL IG4, NBFL RS</p>   |
|  | <p><b>L285</b><br/>CONNECTOR 2-POLE MALE</p>   | <p><b>L285</b> <i>Ventura</i><br/>WRIGHTBUS IG4</p>   |
|  | <p><b>L336-001</b><br/>PORTAL SEAL TOP – 1600L<br/><br/># USED ON L781,M442,M650 PORTAL SEAL ASSYS</p> | <p><b>L336-001</b> <i>Ventura</i><br/>MCV SD 112/124RLE/DD EVOSSETI IG4, EVORA IG4, TEMSA SD IG4</p>  |







|   |   |   |
|---|---|---|
|    | <p><b>L337-001</b><br/>PORTAL SEAL SIDE – 2500L</p> <p># USED ON L781,M442,M650<br/>PORTAL SEAL ASSYS</p> | <p><b>L337-001</b> <i>Ventura</i><br/>MCV SD 112/124RLE/DD EVOSETI<br/>IG4, EVORA IG4, TEMSA SD IG4</p> |
|    | <p><b>L737</b><br/>IG4 FLAP FRAME SIDE PLATE</p>  | <p><b>L737</b> <i>Ventura</i></p>   |
|    | <p><b>L744</b><br/>BEARING POINT<br/>(IG4 ACTIVE FLAPS)</p>   | <p><b>L744</b> <i>Ventura</i><br/>NBFL IG4</p>  |
|   | <p><b>L745</b><br/>Ø8 BEARING BUSH<br/>ID=8.25x12. OD=9.12<br/>F=13x0.42</p>                              | <p><b>L745</b> <i>Ventura</i><br/>(ALL IG4 DOOR FLAPS)</p>  |
|    | <p><b>L778</b><br/>LOWER IG.4 SHAFT (FLAP) BRKT<br/>(Bush if required=L782)</p>                           | <p><b>L778</b> <i>Ventura</i></p>   |
|  <p><small>Corner lip of side and upper panels to be connected properly and in one surface. Failure of this, aspects to decrease stress.</small></p> | <p><b>L781</b><br/>PORTAL RUBBER U-FRAME 1350<br/># PROFILES SIDE = L337-001,<br/>TOP = L336-001)</p>     | <p><b>L781</b> <i>Ventura</i><br/>MCV SD 112/124RLE/DD EVOSETI<br/>IG4, TEMSA SD IG4</p>                |
|    | <p><b>L782</b><br/>Ø12.35 NYLON BEARING BUSH<br/>MFM<br/>ID=12.35x8 OD=18.0<br/>F= Ø23.75x2.9</p>         | <p><b>L782</b> <i>Ventura</i></p>   |

|   |   |  |
|---|---|--|
|                | <p><b>L787</b><br/>HANDRAIL LH 1290 BEND<br/>(UNPAINTED)</p>                                      | <p><b>L787</b> <i>Ventura</i></p>                                      |
|               | <p><b>L788</b><br/>HANDRAIL RH 1290 BEND<br/>(UNPAINTED)</p>                                      | <p><b>L788</b> <i>Ventura</i></p>                                      |
|  <p>L886</p> | <p><b>L886</b><br/>PIVOT POINT BOLT</p>   | <p><b>L886</b> <i>Ventura</i></p>                                      |
|  <p>L794</p> | <p><b>L794</b><br/>FLAP TORSION SPRING<br/>(IG4 ACTIVE FLAPS)<br/><br/>UPGRADED &gt; SEE S555</p> | <p><b>L794</b> <i>Ventura</i><br/>EARLIER IG4 ACTIVE FLAPS 2010-13</p> |
|  <p>L805</p> | <p><b>L805</b><br/>BEARING LOCK FLCTEY<br/>(IG4 DOORSHAFTS)</p>                                   | <p><b>L805</b> <i>Ventura</i></p>                                      |

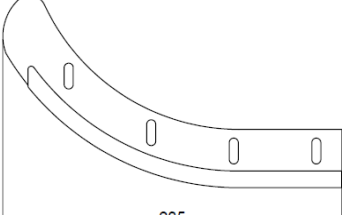
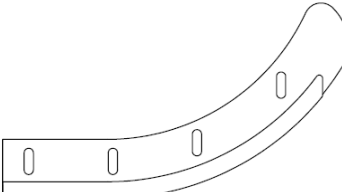
|   |   |   |
|---|---|---|
|    | <p><b>L846-001</b> (530mm)<br/> <b>L846-002</b> (560mm)<br/> <b>L846-003</b> (509mm)<br/> <b>L846-004</b> (484mm)<br/> <b>L846-005</b> (410mm)<br/>                 IG4 FLAP ASSEMBLY LH</p> <p># BEARING BUSH = L745</p> | <p><b>L846-001</b> <i>Ventura</i><br/> <b>L846-002</b> <i>Ventura</i><br/> <b>L846-003</b> <i>Ventura</i><br/> <b>L846-004</b> <i>Ventura</i><br/> <b>L846-005</b> <i>Ventura</i><br/>                 IG4 DOORS</p> <p># = LENGTH CODE, SPECIFIC TO EACH VEHICLE<br/>                 &gt; ADL,MCV,WRIGHTBUS</p> |
|    | <p><b>L846-001</b> (530mm)<br/> <b>L846-002</b> (560mm)<br/> <b>L846-003</b> (509mm)<br/> <b>L846-004</b> (484mm)<br/> <b>L846-005</b> (410mm)<br/>                 IG4 FLAP ASSEMBLY LH</p> <p># BEARING BUSH = L745</p> | <p><b>L846-001</b> <i>Ventura</i><br/> <b>L846-002</b> <i>Ventura</i><br/> <b>L846-003</b> <i>Ventura</i><br/> <b>L846-004</b> <i>Ventura</i><br/> <b>L846-005</b> <i>Ventura</i><br/>                 IG4 DOORS</p> <p># = LENGTH CODE, SPECIFIC TO EACH VEHICLE<br/>                 &gt; ADL,MCV,WRIGHTBUS</p> |
|  | <p><b>M195</b><br/>                 BUSH DIA20-16 L=25 POM</p>  | <p><b>M195</b> <i>Ventura</i><br/>                 WRIGHTBUS IG4</p>  |
|  | <p><b>M298</b><br/>                 PORTAL SEAL IG TOP</p>  | <p><b>M298</b> <i>Ventura</i><br/>                 WRIGHTBUS STREETLIE / EURO6 IG4</p>  |
|  | <p><b>M299</b><br/>                 PORTAL SEAL IG SIDE L=2200</p>  | <p><b>M299</b> <i>Ventura</i><br/>                 WRIGHTBUS STREETLIE / EURO6 IG4</p>  |
|  | <p><b>M300</b><br/>                 PORTAL RUBBER U PROFILE 1290<br/>                 (HESS) MIDI</p> <p># PROFILES VERT = M299,<br/>                 HORZ = M298)</p>  | <p><b>M300</b> <i>Ventura</i><br/>                 WRIGHTBUS STREETLIE / EURO6 IG4</p>  |

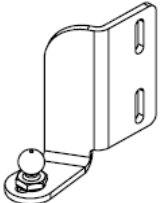
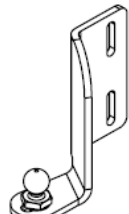
|   |   |  |
|---|---|--|
|    | <p align="center"><b>M414</b><br/>DOOR PROFILE L463 - PLUG FOR<br/>SENS EDGE WIRE ENTRY</p>                       | <p align="center"><b>M414</b> <i>Ventura</i><br/><b>WRIGHTBUS IG4</b></p>  |
|  <p><small>Center line of side and opposite to the corner assembly and on one surface. Repeat all items, mirrored to opposite sides.</small></p> | <p align="center"><b>M442</b><br/>PORTAL U-FRAME IG 1290<br/># PROFILES VERT = L337-001,<br/>HORZ = L336-001)</p> | <p align="center"><b>M442</b> <i>Ventura</i><br/><b>MCV SD 112/124RLE IG4</b><br/><b>EVORA</b></p>                 |
|    | <p align="center"><b>M592</b><br/>GUIDING BRACKET LEFT</p>  | <p align="center"><b>M592</b> <i>Ventura</i><br/><b>ADL E200 SD IG4 + E300 SD IG4 + E400</b><br/><b>DD IG4</b></p> |
|   | <p align="center"><b>M593</b><br/>GUIDING BRACKET RIGHT</p>   | <p align="center"><b>M593</b> <i>Ventura</i><br/><b>ADL E200 SD IG4 + E300 SD IG4 + E400</b><br/><b>DD IG4</b></p> |
|    | <p align="center"><b>M670</b><br/>GUIDING BRACKET LEFT</p>  | <p align="center"><b>M670</b> <i>Ventura</i><br/><b>MCV SD 112/124RLE IG4</b></p>                                  |
|    | <p align="center"><b>M671</b><br/>GUIDING BRACKET RIGHT</p>   | <p align="center"><b>M671</b> <i>Ventura</i><br/><b>MCV SD 112/124RLE IG4</b></p>                                  |



|   |   |   |
|---|---|---|
|    | <p align="center"><b>M717</b><br/>GUIDING BRACKET</p>             | <p align="center"><b>M717</b> <i>Ventura</i><br/>WRIGHTBUS ECLIPSE SD IG4 + GEMINI DD IG4 + NBFL DD IG4/IG4 PLAT</p>            |
|    | <p align="center"><b>M918</b><br/>SLIDE PLATE POM LEFT SMALL</p>  | <p align="center"><b>M918</b> <i>Ventura</i><br/>ADL E200 SD IG4</p>  |
|    | <p align="center"><b>M919</b><br/>SLIDE PLATE POM RIGHT SMALL</p> | <p align="center"><b>M919</b> <i>Ventura</i><br/>ADL E200 SD IG4</p>  |
|   | <p align="center"><b>N010</b><br/>RUBBER COVERPLATE</p>           | <p align="center"><b>N010</b> <i>Ventura</i><br/>WRIGHTBUS STREETLITE IGE</p>   |
|  | <p align="center"><b>N035</b><br/>DOOR SHAFT SUPPORT LEFT</p>     | <p align="center"><b>N035</b> <i>Ventura</i><br/>MCV SD 112/124RLE IG4</p>  |
|  | <p align="center"><b>N036</b><br/>DOOR SHAFT SUPPORT RIGHT</p>    | <p align="center"><b>N036</b> <i>Ventura</i><br/>MCV SD 112/124RLE IG4</p>  |
|  | <p align="center"><b>N058</b><br/>DOOR SHAFT SUPPORT ASSY</p>     | <p align="center"><b>N058</b> <i>Ventura</i><br/>WRIGHTBUS ECLIPSE SD IG4 + GEMINI DD IG4 + STREETLITE SD IG4 + NBFL DD IG4</p> |

|  |   |  |
|--|---|--|
|  | <p><b>N059</b><br/>BOTTOM SUPPORT R 90 (TOGGLE NUT)</p> | <p><b>N059</b> <i>Ventura</i><br/>WRIGHTBUS ECLIPSE SD IG4 + GEMINI DD IG4 + STREETLITE SD IG4 + NBFL DD IG4</p> |
|  | <p><b>N881</b><br/>BOTTOM SUPPORT LH ASSY 90</p>        | <p><b>N881</b> <i>Ventura</i><br/>ADL E200/E400 IG4</p>  |
|  | <p><b>N882</b><br/>BOTTOM SUPPORT RH ASSY 90</p>        | <p><b>N882</b> <i>Ventura</i><br/>ADL E200/E400 IG4</p>  |
|  | <p><b>O400</b><br/>BOTTOM SUPPORT R 77 (TOGGLE NUT)</p> | <p><b>O400</b> <i>Ventura</i><br/>WRIGHTBUS NBFL DD IG4/IG4 PLAT</p>   |
|  | <p><b>O411</b><br/>TAPPING PLATE WEDGE</p>              | <p><b>O411</b> <i>Ventura</i></p>  |
|  | <p><b>O412</b><br/>PIVOT POINT BOTTOM NBFL</p>          | <p><b>O412</b> <i>Ventura</i><br/>WRIGHTBUS NBFL IG4, NBFL IG4 PLAT</p>  |
|  | <p><b>O413</b><br/>PIVOT POINT TOP WRIGHT NBFL</p>      | <p><b>O413</b> <i>Ventura</i><br/>WRIGHTBUS NBFL IG4, NBFL IG4 PLAT</p>  |

|  |  |   |
|--|--|---|
|  | <p align="center"><b>O415</b><br/>BENDED DOOR SUPPORT TOP</p>                  | <p align="center"><b>O415</b> <i>Ventura</i><br/>WRIGHTBUS NBFL DD IG4 PLAT</p> |
|  | <p align="center"><b>O553</b><br/>GUIDING BRACKET LH</p>                       | <p align="center"><b>O553</b> <i>Ventura</i></p>                                |
|  | <p align="center"><b>O554</b><br/>GUIDING BRACKET RH</p>                       | <p align="center"><b>O554</b> <i>Ventura</i></p>                                |
|  | <p align="center"><b>O658</b><br/>CATCH PIN BENDED DOOR</p>                    | <p align="center"><b>O658</b> <i>Ventura</i></p>                                |
|  | <p align="center"><b>O664</b><br/>ADAPTER SLIDE PLATE</p>                      | <p align="center"><b>O664</b> <i>Ventura</i></p>                                |
|  | <p align="center"><b>O670</b><br/>BENDED DOOR SUPPORT BOTTOM</p>               | <p align="center"><b>O670</b> <i>Ventura</i><br/>WRIGHTBUS NBFL DD IG4 PLAT</p> |
|  | <p align="center"><b>O689</b><br/>M16x60(1.5) SOC HD SCREW<br/>(DOORSHAFT)</p> | <p align="center"><b>O689</b> <i>Ventura</i><br/>WRIGHTBUS NBFL IG4 PLAT</p>    |

|   |   |   |
|---|---|---|
|    | <p align="center"><b>O708</b><br/>PORTAL SEAL IG4 WB NBFL DR5</p>   | <p align="center"><b>O708</b> <i>Ventura</i></p>  |
|    | <p align="center"><b>P725</b><br/>GUIDING BRACKET L 72.5mm</p>  | <p align="center"><b>P725</b> <i>Ventura</i><br/>WRIGHTBUS ECLIPSE SD IG4</p>   |
|    | <p align="center"><b>P726</b><br/>GUIDING BRACKET R 72.5mm</p>  | <p align="center"><b>P726</b> <i>Ventura</i><br/>WRIGHTBUS ECLIPSE SD IG4</p>   |
|   | <p align="center"><b>P840</b><br/>TAPPING STRIP 2Xm5</p>  | <p align="center"><b>P840</b> <i>Ventura</i><br/>WRIGHTBUS IG4</p>  |
|  | <p align="center"><b>Q913</b><br/>POM BLOCK BENDED DOOR</p>   | <p align="center"><b>G419</b> <i>Ventura</i><br/>WRIGHTBUS IG4</p>  |
|  | <p align="center"><b>R042</b><br/>SEAL VA0155-L 1880</p> <p align="center"><b>R043</b><br/>SEAL VA0155-R 1880</p>   | <p align="center"><b>R042</b> <i>Ventura</i><br/>WRIGHTBUS IG4</p> <p align="center"><b>R043</b> <i>Ventura</i><br/>WRIGHTBUS IG4</p> |
|  | <p align="center"><b>S555</b><br/>EXTENSION SPRING TR1310</p>  <p align="center">&lt; PREVIOUS VERSION</p> <p align="center"># REPLACES L794</p> | <p align="center"><b>S555</b> <i>Ventura</i><br/>IG4 ACTIVE FLAPS (2013 &gt;)</p>   |

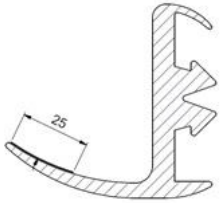
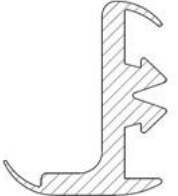
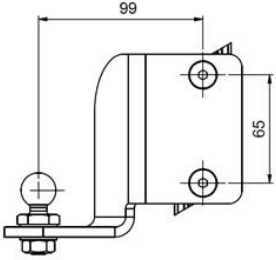
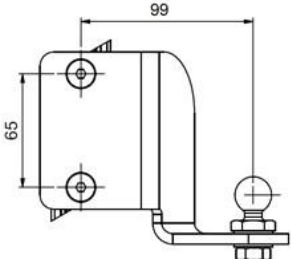

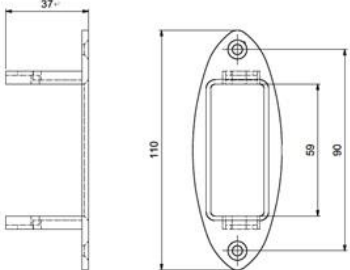
|   |  |  |
|---|--|--|
|    | <p><b>U446-001</b><br/>PORTAL SEAL TOP L=1600</p>  | <p><b>U446-001</b> <i>Ventura</i><br/>ADL E200 EV</p>  |
|    | <p><b>U447-001</b><br/>PORTAL SEAL SIDE L=2200</p>   | <p><b>U447-001</b> <i>Ventura</i><br/>ADL E200 EV</p>  |
|    | <p><b>U537</b><br/>IG BOTTOM SUPPORT L100<br/>TOGGLE NUTS</p>  | <p><b>U537</b> <i>Ventura</i><br/>ADL E400 MMC</p>   |
|   | <p><b>U538</b><br/>IG BOTTOM SUPPORT R100<br/>TOGGLE NUTS</p>  | <p><b>U538</b> <i>Ventura</i><br/>ADL E400 MMC</p>   |
|  | <p><b>VA0184 / VA0186</b><br/>SEAL VA0115-L 2200 / 2000<br/><b>VA0185 / VA0187</b><br/>SEAL VA0115-R 2200 / 2000</p> | <p><b>VA0184/VA0186</b><br/><b>VA0185/VA0187</b><br/><i>Ventura</i><br/>ADL E200, WRIGHTBUS STREETLITE<br/>IG4 LATER</p> |
|  | <p><b>VA0317</b><br/>GUIDING SHAFT ASS. 98 M10<br/><br/># ROLLER ASSY = J301</p>                                     | <p><b>VA0317</b> <i>Ventura</i><br/>ADL E200 EV</p>  |
|  | <p><b>VA0541</b><br/>SENSOR BRACKET</p>  | <p><b>VA0541</b> <i>Ventura</i></p>  |

|   |  |   |
|---|--|---|
|    | <p><b>VA2287</b><br/>SEAL VA0115-L 1870_8K2</p> <p><b>VA2288</b><br/>SEAL VA0115-R 1870_8K2</p> <p># ASSY INCL SENS EDGE</p> | <p><b>VA2287</b> <i>Ventura</i><br/>WRIGHTBUS STREETLITE IGE</p>                |
|    | <p><b>VA2343</b></p> <p><b>VA2344</b><br/>Portal Profile (P072)</p>  | <p><b>VA2343,VA2344</b> <i>Ventura</i></p>                                      |
|   | <p><b>VA3302</b><br/>FOOT SIDE SENS EDGE – IG4</p>   | <p><b>VA3302</b> <i>Ventura</i><br/>WRIGHTBUS NBFL PLATFORM (NBFL IG4 PLAT)</p> |
|  | <p><b>VA3699</b><br/>FOOT SENS EDGE - IG4</p>  | <p><b>VA3699</b> <i>Ventura</i><br/>WRIGHTBUS NBFL PLATFORM (NBFL IG4 PLAT)</p> |
|  | <p><b>VA3702</b><br/>COVER CENTRE - NBFL FOOT SENS</p>   | <p><b>VA3702</b> <i>Ventura</i><br/>WRIGHTBUS NBFL</p>                          |
|  | <p><b>VA3703</b><br/>COVER LEFT - NBFL FOOT SENS</p>   | <p><b>VA3703</b> <i>Ventura</i><br/>WRIGHTBUS NBFL</p>                          |

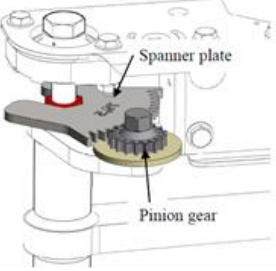
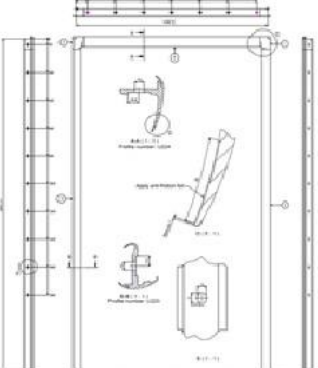
|   |   |  |
|---|---|--|
|  | <p><b>VA3860</b><br/>DOORSHAFT TORQUE TOOL – IG4</p> <p><b>VA4146</b><br/>DOORSHAFT TORQUE TOOL – IG3</p> | <p><b>VA3860</b> <i>Ventura</i></p> <p><b>VA4146</b> <i>Ventura</i></p> <p><b>ALL INWARD GLIDERS</b></p> <p><b>IG4 – 2010 &gt;</b></p> <p><b>IG3 – 2009 &lt;</b></p> |
|  | <p><b>V4286</b><br/>PORTAL SEAL 1290 STRIP MOUNT</p>  | <p><b>VA4286</b> <i>Ventura</i></p>  |