









SINGLE/DOUBLE SLIDING DOOR KIT PART OPTIONS

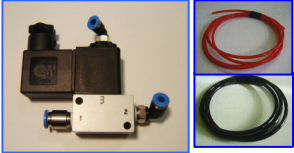
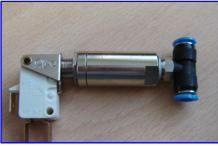
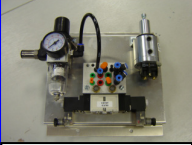

Description	Part Number	Ex works Unit Price £	Image
Internal Double Pneumatic Button	BUT001-ASY-P (Normally 2 per kit Pneumatic systems)		
Internal Double Electric Button	BUT007-ASY		
Round External Emergency Open Pneumatic Button	BUT003-ASY-P		
Dump Valve Assy with 8mm fittings	VAL013A-KIT-01		
Roller Lever Valve Kit	VAL039U-KIT-01		
Filter Reg/Gauge, Soft Start Kit	PNE003U-KIT-01		
Airbleed Spool Valve Kit	VAL001U-KIT-01 (Single/Double Door Cylinder)		
Airbleed Spool Valve 24v D/Solenoid Kit	VAL002U-KIT-01 (Single/Double Door Cylinder)		
Pneumatic UDV Valve 20N	VAL011U		
Pressure Limiting Valve Kit	VAL042U-KIT-01		

Air Reservoir 20ltr Kit	PNE036D-KIT-01		
Mini Cylinder 25x50 Kit	CYL040U-KIT-01		
5 KPH Air Bleed Button Inhibitor Kit	KIT007-04		
Pneumatic-Electric 4bar Falling Pressure Indicator Kit	KIT009-03		
Control unit ref only	PLT028-01=COMPACT PLT028-02=SINGLE PLT028-03=DOUBLE PLT028= (Mount Plate)		   <p>PLT028-01-ASY PLT028-02-ASY PLT028-02-ASY</p>
RODLESS CYLINDERS >			
    			
Rodless Cylinder 25x1080 Stroke	CYL225-1080		
Rodless Cylinder 25x545 Stroke	CYL225-545		

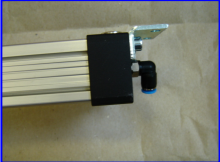
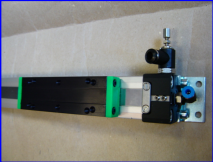
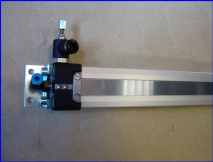
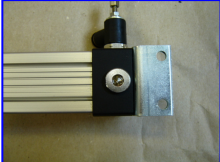
Prices exclude packing/delivery costs unless specified otherwise, all items shipped on standard next day service. Pricing based on order value and timed service required.

Transport Door Solutions Ltd, 43 Broton Drive, Halstead, Essex, CO9 1HB T- 01787 473000 F- 01787 477040

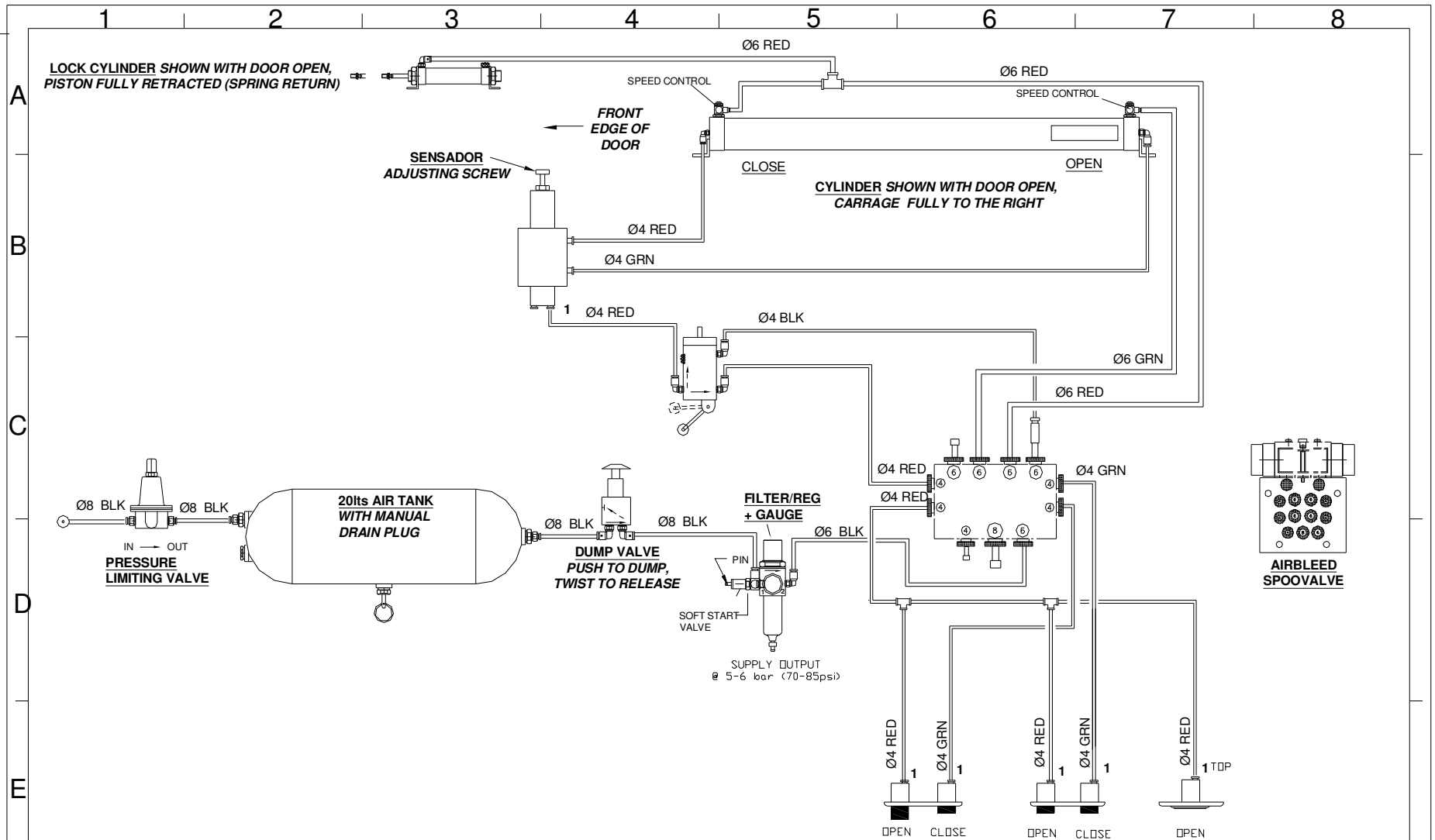

KEILLOR COACH CRAFT SLID KIT-01 PUSH TO CLOSE

TO SET SOFT START VALVE
HOLD PIN INSERT 1.5 ALLEN KEY INTO END,
TURN CLOCKWISE FULLY HOME,
THEN TURN ANTI-CLOCKWISE "2" FULL TURNS.
PIN WILL POP OUT WHEN SYSTEM FULLY LOADED.

SENSADOR ADJUSTING SCREW
CLOCK WISE HEAVEY DETECTION
ANTI-CLOCK WISE SOFTER DETECTION

TOLERANCES ON DIMENSIONS: Unless otherwise Stated
 DN DIMENSIONS OVER 1000± DN ANGLES: ± 10N CHAMFERS: ± 5º
 DN DIMENSIONS OF WHOLE NUMBERS ONLY: ± 10
 DN DIMENSIONS TO 1 DECIMAL PLACE: ± 0.5
 DN DIMENSIONS TO 2 DECIMAL PLACES: ± 0.25
 METRIC THREADS TO BS 3643 CLASS 6º (EXTERNAL) DR 6H (INTERNAL)
 B.S.P. THREADS TO BS 2779 MEDIUM FIT.

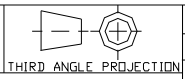

SCALE: 1/1	MATERIAL:		
DRAWN BY: A.W.L.SCH	FINISH:		
DATE: 22/03/10	IF IN DOUBT ASK DO NOT SCALE	REMOVE ALL BURRS AND SHARP EDGES	DESCRIPTION: RODLESS CYLINDER CONTROL CIRCUIT
ALL DIMENSIONS IN MM / INCHES	TEL:-01787 473000 FAX:-01787 477040 sales@transportdoorsolutions.co.uk	PART No.:	SH1 1
REVISION		DRG No. PWL301	rev 1